

( ) 寸法は反対側を示す。

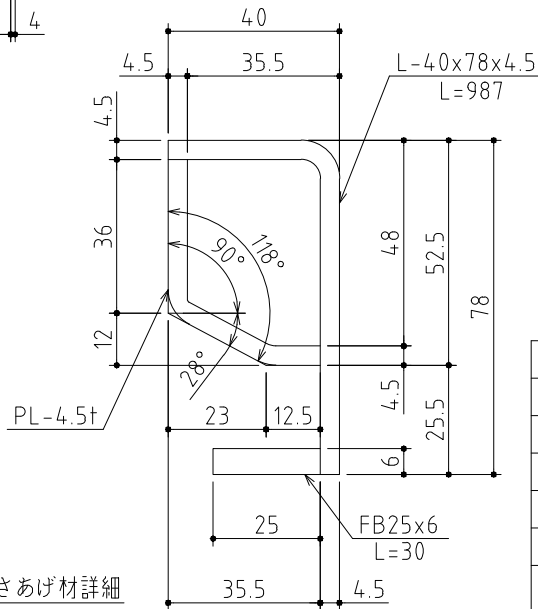
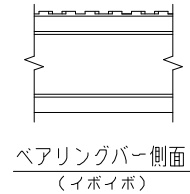
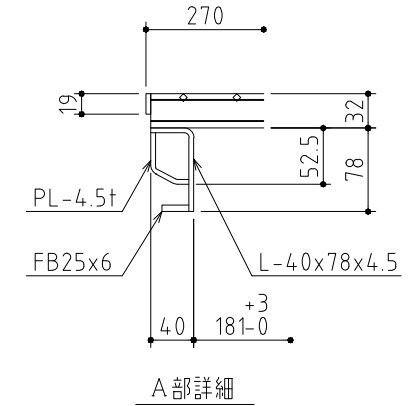
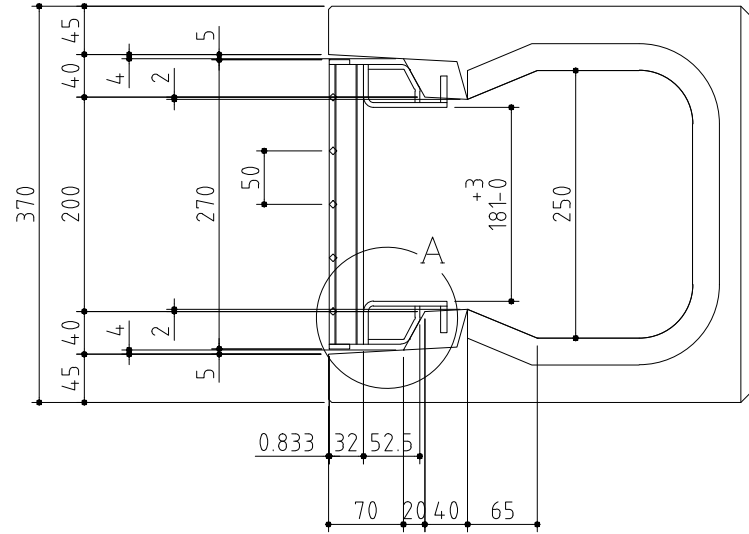

記事

1. 型式 X5DCT25 (X5XO32-S型)
2. 表面处理 グレーチング：亜鉛メッキ (HDZ55)
3. 設計条件 荷重：T-25 (一輪5t)  
衝撃係数  $i = 0.1$  (ベアリングバーに直角)

APPROVED BY		WORK NO.
JUDGED BY		
ENG' R IN CHARGE		DRAWING NO.
CHECKED BY	川口	GM10F41706D
DRAWN BY	西野	
DATE DRAWN	2010/10/15	
SCALE	1/7	DAIKURE CO., LTD.